

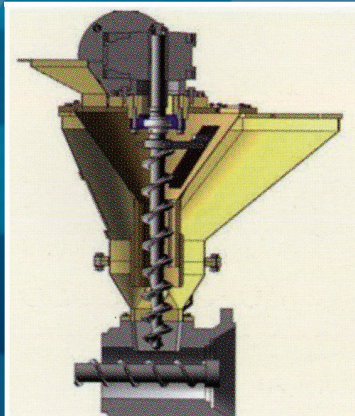

IMPIANTI PER IL RICICLO E MACINAZIONE MATERIE PLASTICHE

RISPARMI TECNOLOGICI

Per una gestione ottimale degli scartiprodotto durante la trasformazione delle materie plastiche, **Aertecnica Croci** propone alcune soluzioni allo stato dell'arte, che garantiscono benefici a breve e a lungo termine a tutti, costruttori di impianti cast o bolla o convert che siano.



tramoggia per alimentazione fluff su estrusore e materiale vergine (chips)

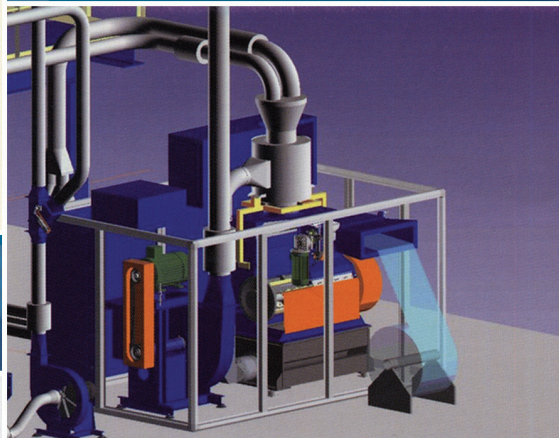

impianto di macinazione

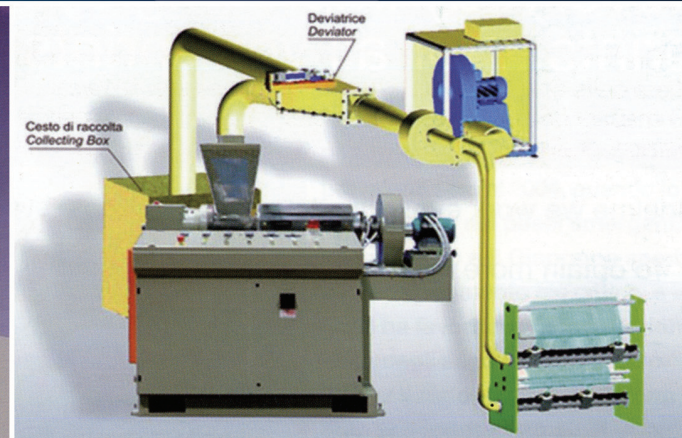

estrusore per recupero rifili da linee blow film

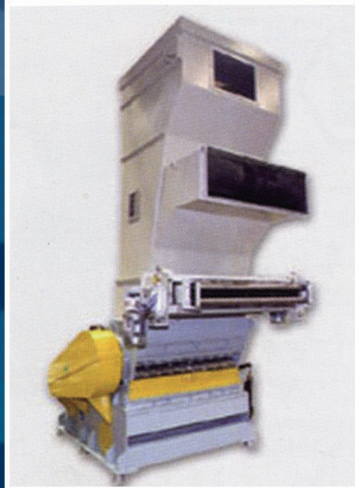

mulino per film-linee: cast e blow film con tramo recupero bobine

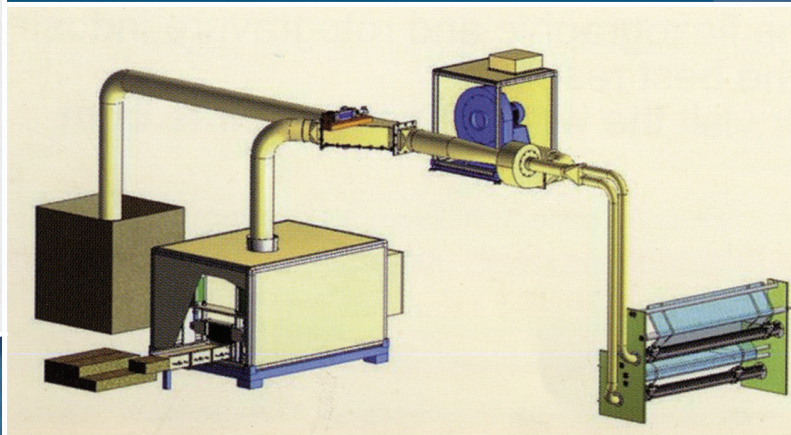

compattatore di rifili plastici

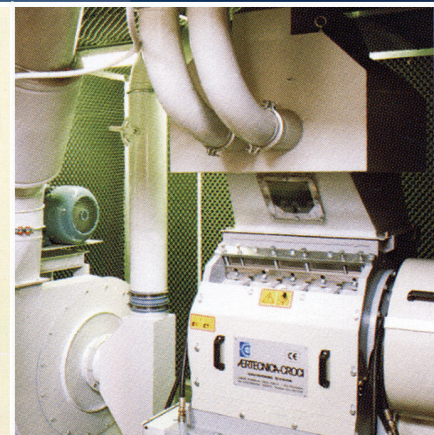

gruppo macinazione rifili

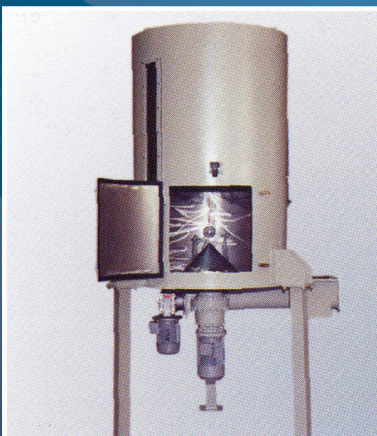

silo di stoccaggio alimentazione fluff in linea

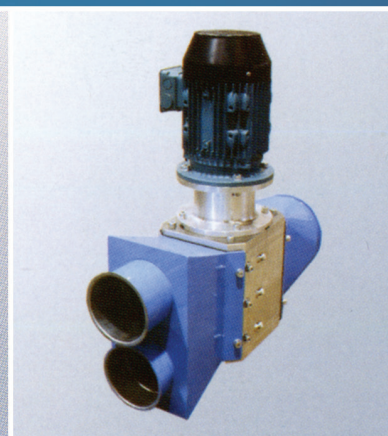

chopper-line

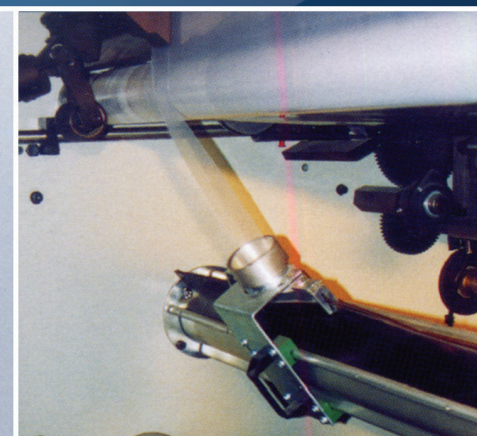

presa rifili in bolla



AERTECNICA CROCI S.R.L.
ENGINEERING DIVISION

via ticinese, 8 - 28050 - Pombia (NO)
tel +39 0321 956 498 - fax +39 0321 957 259
www.aercroci.com - info@aercroci.com